

CHLOROPHYLL METER SPAD-502Plus

INSTRUCTION MANUAL



KONICA MINOLTA

Safety Symbols

The following symbols are used in this manual to prevent accidents which may occur as result of incorrect use of the instrument.



Denotes a sentence regarding a safety warning or note.
Read the sentence carefully to ensure safe and correct use.



Denotes a prohibited operation.
The operation must never be performed.

Safety Precautions

To ensure correct use of this instrument, read the following points carefully and adhere to them. After you have read this manual, keep it in a safe place where it can be referred to anytime a question arises.



WARNING(Failure to adhere to the following points may result in death or serious injury.)



Do not use the instrument in places where flammable or combustible gases (gasoline etc.) are present. Doing so may cause a fire.



Do not dispose of batteries in fire, short their terminals, apply heat to them, or disassemble them. Also, do not recharge them. Doing so may cause explosion or heat generation, resulting in fire or injury.



CAUTION (Falling to adhere to the following points may result in injury or damage to the instrument or other property.)



Do not use batteries other than those specified by KONICA MINOLTA SENSING. When installing batteries in the instrument, make sure that they are correctly oriented according to the (+) and (-) marks. Failure to adhere to these instructions may cause batteries to explode or leak electrolyte, resulting in fire, injury or air pollution.



Do not use wet batteries. Do not use the instrument if water is in the battery chamber. Failure to adhere to these instructions may cause batteries to explode or heat, resulting in fire or injury.

Chlorophyll Meter SPAD-502Plus is a compact, lightweight meter which can be used to determine the amount of chlorophyll present in plant leaves.

The amount of chlorophyll present in plant leaves can serve as an indicator of the overall condition of the plant itself. In general, healthier plants will contain more chlorophyll than less healthy ones.

The SPAD value determined by the SPAD-502Plus provides an indication of the relative amount of chlorophyll present in plant leaves. This SPAD value can be used to determine if and when supplementary fertilizer is necessary. Through proper use of measured SPAD values, it is possible to produce healthier plants, resulting in a larger and higher-quality crop yield.

Please read and study this manual before using the Chlorophyll Meter SPAD-502Plus for the first time, and keep it handy for future reference.

STATEMENT OF FCC COMPLIANCE

This device complies with Part 15 of the FCC Rules. Operation is subject to the following two conditions: (1) This device may not cause harmful interference, and (2) this device must accept any interference received, including interference that may cause undesired operation. Change or modifications not approved by the party responsible for compliance could void the user's authority to operate the equipment. This equipment has been tested and found to comply with the limits for a Class B digital device, pursuant to Part 15 of the FCC Rules. These limits are designed to provide reasonable protection against harmful interference in a residential installation. This equipment generates, uses and can radiate radio frequency energy and, if not installed and used in accordance with the instructions, may cause harmful interference to radio communications. However, there is no guarantee that interference will not occur in a particular installation. If this equipment does cause harmful interference to radio or television reception, which can be determined by turning the equipment off and on, the user is encouraged to try to correct the interference by one or more of the following measures:
Reorient or relocate the receiving antenna.

Increase the separation between the equipment and receiver.

Connect the equipment into an outlet on a circuit different from that to which the receiver is connected. Consult the dealer or an experienced radio / TV technician for help.

This Class B digital apparatus meets all requirements of the Canadian Interference-Causing Equipment Regulations.

Cet appareil numérique de la classe B respecte toutes les exigences du Règlement sur le matériel brouilleur du Canada.

CONTENTS

Description	1
Contents	2
Names of parts	3
Standard accessories.....	3
Displays and indications	4
Display examples.....	4
Error indications.....	5
Preparations	6
Installing batteries.....	6
Attaching strap.....	6
Calibration	7
Taking measurements	8
Using the depth stop.....	9
Memory functions	10
Inputting compensation values	12
Standardizing several meters.....	13
Using the reading checker	14
Troubleshooting guide	16
Care and storage	17
Measuring principle	18
Illuminating/measuring system.....	20
Calculations.....	21
Technical details	22

NAMES OF PARTS

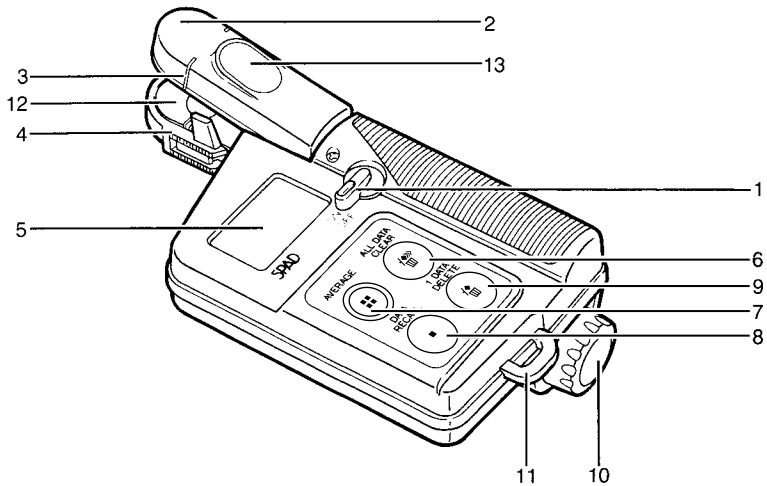

- | | |
|---------------------------|---|
| 1. Power switch: | Switches power on and off. |
| 2. Measuring head: | When closed, measurement is performed. |
| 3. Center line: | Indicates the center of the measuring area. |
| 4. Sliding depth stop: | Can be set to ensure that measurements of all samples are taken at the same distance from the sample edge. Can be removed if desired. |
| 5. LCD panel: | Displays data and other information. |
| 6. AVERAGE: | Calculates the average value of all data in memory. |
| 7. ALL DATA CLEAR: | Deletes all data in memory. |
| 8. DATA RECALL: | Recalls data stored in the previous data number to the display. |
| 9. 1 DATA DELETE: | Deletes the displayed data. |
| 10. Battery chamber cover | |
| 11. Strap eyelet | |
| 12. Sample slot: | Samples are inserted here for measurement. |
| 13. Finger rest: | Press here to close measuring head. |

Standard Accessories

Strap Soft case Reading checker 2 AA-size batteries

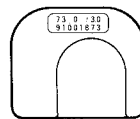

DISPLAYS AND INDICATIONS

The LCD panel is shown below with all segments displayed.

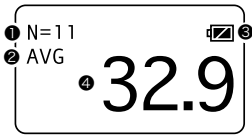

- ① Number of data in memory when “ N = ” displayed; data number being displayed when “ No.= ” is shown.
If “ * ” is displayed, the displayed value is greater than 50.0. The accuracy of measured values of greater than 50.0 cannot be guaranteed.
- ② Indicates displayed data is the average value. See p.10.
- ③ Low battery power indicator; appears when battery power is almost exhausted and batteries should be replaced. See p.6.
- ④ Data or operation message

Display Examples

After power switch has been turned to **ON**:



After measurement:

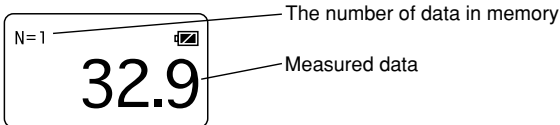

After **AVERAGE** has been pressed:

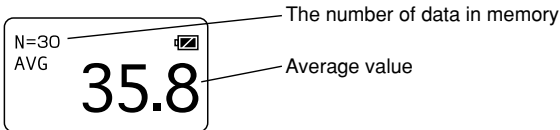

After **DATA RECALL** has been pressed:



Error Indications



If it appears during calibration, measuring head was not properly closed. Perform calibration again.

(1)

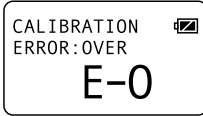

Calibration error : transmitted light was excessive (1) or insufficient (2). If (1), perform calibration again. If (2), clean the emitting and receiving windows of the measuring head, and then perform calibration again. If either display continues to appear, the meter may be malfunctioning.

(2)



Measuring head was not completely closed during measurement. Take measurement again, being sure measuring head is completely closed until measurement is finished. Operation keys will continue to function normally. If this display continues to appear, the meter may be malfunctioning.



Transmitted light was insufficient for measurement. Clean the emitting and receiving windows of the measuring head, and then measure the sample again. If this display continues to appear, the sample cannot be measured.



When a series of beeps sounds and the battery symbol  appears, measurement cannot be performed. Replace batteries before continuing measurements. See p.6.



When the battery symbol  appears, the battery power will be exhausted soon. Prepare for new batteries.

- When the meter is to be stored for more than two weeks, remove the batteries from the meter body.

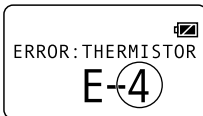

The meter is not functioning properly. Turn the power switch to **OFF**, then turn it back to **ON** again. If the error display continues to appear, the meter is malfunctioning and needs service. (Displays E1 to E5 are used by the service center.)

PREPARATIONS

Installing Batteries

1. Remove the battery chamber cover by turning it in the direction of the arrow on the cover.

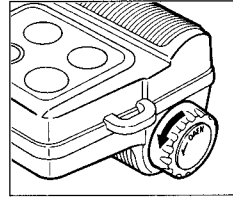

2. Insert two AA-size batteries into the battery chamber. Be sure the battery terminals are positioned as shown.

- Alkaline-manganese batteries can be used.
- Do not mix battery types or ages.

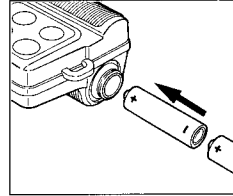

3. Replace the battery chamber cover and turn it in the direction opposite to that of the arrow on the cover until the cover is snug against the meter. Do not overtighten.

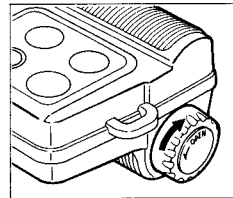

- If the battery symbol appears in the display when the power switch is turned to **ON**, battery power is almost exhausted and batteries should be replaced. If no display appears when the power switch is turned to **ON**, check that batteries are inserted correctly and that they are not "dead".

Attaching Strap

The strap should be attached to the strap eyelet as shown below.

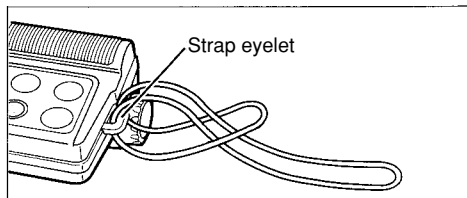

CALIBRATION

Calibration is necessary whenever the meter is switched on after having been switched off. The meter can be calibrated by following the steps below.

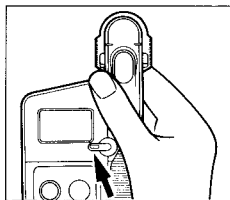

KONICA MINOLTA
SPAD-502 Plus
S/N: 91001873
VER: 1.000000



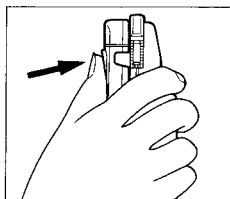

CALIBRATION 



N=0 



CALIBRATION ERROR 

CALIBRATION ERROR: UNDER 

E-U

1. Turn power switch to **ON**. The display shown will appear.

2. With no sample in the sample slot, press on the finger rest to close the measuring head. Hold it closed until a beep sounds and the display shown appears.

Calibration is now complete.

- If a series of beeps sounds and "ERROR" appears in the display, calibration was not performed correctly (measuring head was not completely closed during calibration or was opened before calibration was completed). Repeat step 2, keeping the measuring head completely closed until calibration is finished.
- If the series of beeps sounds and "ERROR" and "E-U" appear in the display, the emitting and/or receiving windows of the measuring head may be dirty. Clean the windows and repeat step 2.

TAKING MEASUREMENTS

The SPAD-502Plus can be easily used to take measurements in the field.

The measuring area is only 2mm × 3mm, allowing small leaves to be measured, and samples may be up to 1.2mm thick. The center line indicates the center of the measuring area. The position of the emitting and receiving windows is indicated in the figure below. The depth stop (p. 9) may be used to keep the measurement depth constant.

Position of emitting and receiving windows

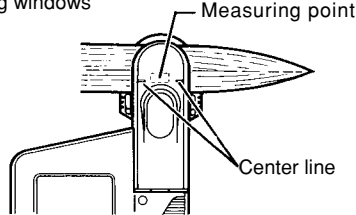

- The SPAD-502Plus is classified as “Class 4” in watertightness according to IEC 60529. It is water-resistant and can be used in the rain. After use, wipe it dry with a clean, soft cloth. Do not immerse it in water or wash it with water.

1. Perform calibration (p. 7).

2. Insert the sample to be measured into the sample slot of the measuring head.

- Be sure the sample completely covers the receiving window.
- Do not attempt to measure extremely thick parts, such as the veins of a leaf. If measuring a leaf that has many fine veins, take several measurements and average them for best results.
- If the emitting and/or receiving windows of the measuring head are dirty or have some water on them, precise measurement cannot be performed. Clean them before measurement.
- When using the meter in direct sunlight, shade the meter with your body to prevent the sunlight from affecting measurements.

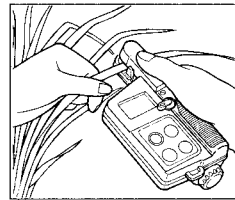

3. Press on the finger rest to close the measuring head. Hold it closed until a beep sounds and the measured value appears in the display. The measurement will automatically be stored in memory.

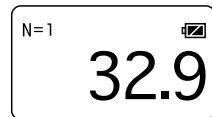

- If a series of beeps sounds and “ERROR” appears in the display, measurement was not performed correctly (measuring head was not closed completely, measuring head was opened before measurement was completed, or sample is too thick or thin). Repeat steps 2 and 3, keeping the measuring head completely closed until measurement is finished.



Using the Depth Stop

The depth stop can be used to set the maximum depth to which samples can be inserted into the sample slot to keep the measuring point constant. It is especially useful when measuring small leaves.

To set the position of the depth stop, squeeze both sides of the depth stop against the sides of the measuring head and slide the depth stop to the desired position. The depth stop can be moved within the range of 0 to 6mm from the center line.

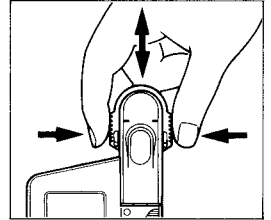
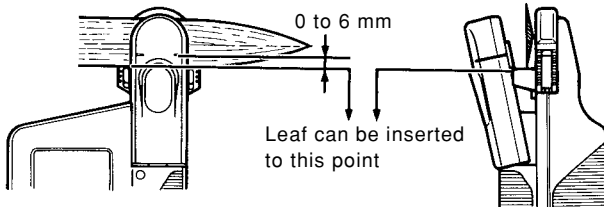



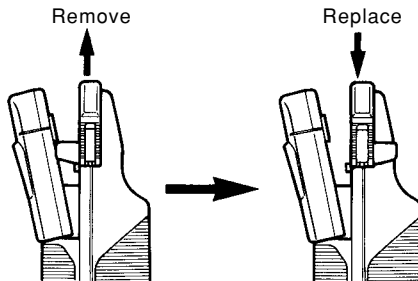

When not using the depth stop, remove it, turn it around (with the tabs facing away from sample slot) and replace it on the measuring head.

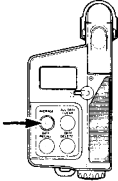

MEMORY FUNCTIONS

Measured data are automatically stored in memory at the time of measurement. The SPAD-502Plus has memory space for up to 30 data. When the memory is full, the data for the first data number (the oldest data in memory) is deleted and the remaining data in memory are shifted, so that the data for data numbers 2 through 30 become the data for data numbers 1 through 29. The new measurement is then stored as data number 30. All data are deleted from memory when the power switch is turned to **OFF**.

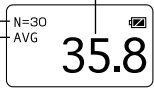
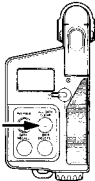
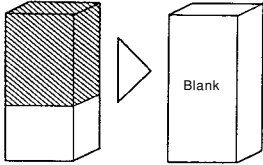
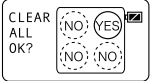
By using the keys of the SPAD-502Plus, it is possible to perform certain operations on data in memory as shown below.

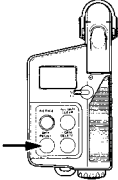
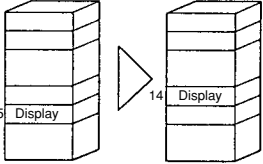
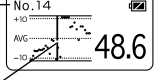
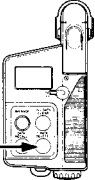
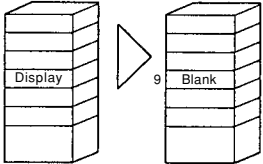
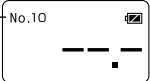
Key name	Function	State of data in memory	Display after operation
AVERAGE 	Calculates the average value of all data in memory.		Number of data in memory Average value  Average indication
ALL DATA CLEAR 	Displays the message confirming that all data in memory may be deleted and then deletes them when pressed again.		 
DATA RECALL 	Recalls the data stored for the previous data number to the display for checking.		Displayed data number  Cursor line : Displayed data number Reverting point : Displayed data
1 DATA DELETE 	Deletes displayed data. Can be used to delete data which is incorrect.		 Data number of deleted data

After displayed data has been deleted using the **1 DATA DELETE**, later measurements will be stored in one of the following ways.

1. If another measurement is taken without changing the data number (while “- - -” is shown in the display or if **AVERAGE** was the only key pressed after data was deleted), the new measured data will be stored in the space for the data number from which data was deleted.

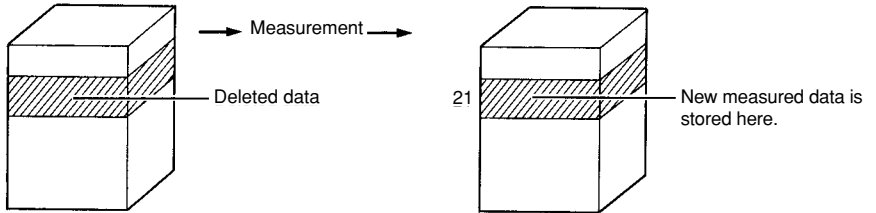

2. If the display is changed to another data number by using the **DATA RECALL**, the remaining data in memory will be shifted up to fill the space for the data number from which data was deleted and the new measured data will be stored in the space for the next empty data number.

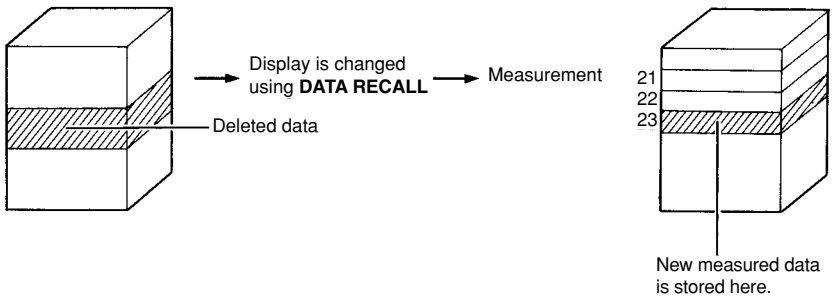

INPUTTING COMPENSATION VALUES

The SPAD-502Plus can use compensation values defined by the user to adjust data if desired, such as for standardizing the response of several meters. Compensation values can be set between -9.9 and 9.9. After a compensation value has been input, data will be calculated according to the following formula:

Displayed value = Measured SPAD value + Compensation value

To input a compensation value:

1. Turn the power switch to **ON** while pressing both **AVERAGE** and **DATA RECALL**. The meter will enter compensation mode and the previous compensation value will be shown in the display. The compensation value will be 0.0 if a compensation value has not been previously input.

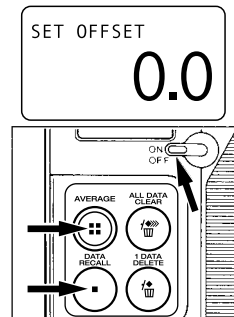

2. Set the compensation value using **ALL DATA CLEAR** and **1 DATA DELETE**. The compensation value will increase by 0.1 each time **ALL DATA CLEAR** is pressed; value will decrease by 0.1 each time **1 DATA DELETE** is pressed. The compensation value can be set between -9.9 and 9.9 in 0.1 steps. The compensation value is set to 0.0 at the factory.

- The reading checker should not be used to decide the compensation value.

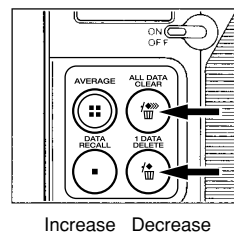

3. After setting the desired value, press **AVERAGE**. The displayed value will be stored in memory and input of compensation value is complete. Switch off the power and then switch it on again to start operation.

- If the power is switched off without pressing **AVERAGE**, the value set in step 2 will not be stored and the previous compensation value will remain in memory.

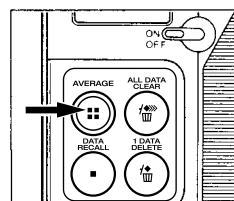

When the compensation value is set to other than 0.0, the following display sequence occurs when the power switch is turned from **OFF** to **ON**.

Power switch turned to **ON**

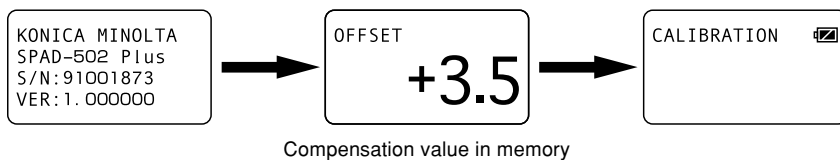

When "CALIBRATION" appears, calibration can be performed according to the procedure on p. 7.

When the compensation value is set to 0.0, compensation value in memory is not displayed when the power switch is turned from **OFF** to **ON**.

Power switch turned to **ON**

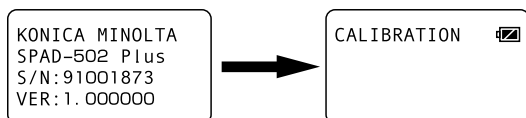

Standardizing Several Meters

Different SPAD-502Plus units will yield slightly different results even if the same area of the leaf is measured. By following the steps below and inputting compensation values, these differences can be reduced to a minimum.

1. Select one meter as the master unit.
2. Measure the same area of a leaf several times with the master unit and push **AVERAGE** to obtain the average value.
3. Take several measurements of the same area measured in step 2 using the other meters and press **AVERAGE** of each meter so that all units display the average measured value.
4. Subtract the average value displayed by each meter from the average value displayed by the master unit to obtain the compensation value for each meter.
5. Input the compensation value for each meter as calculated in step 4 according to the procedure for inputting compensation values on p. 12.

USING THE READING CHECKER

A reading checker is included with the SPAD-502Plus. This reading checker can be used to check that the SPAD-502Plus is operating normally, and should be used periodically for best accuracy.

To use the reading checker:

1. Turn the power switch to **ON** while pressing both **1 DATA DELETE** and **DATA RECALL**. The meter will enter its check mode and "CHECK MODE" will appear momentarily in the display. Then the display will change and "CALIBRATION CH" will appear.

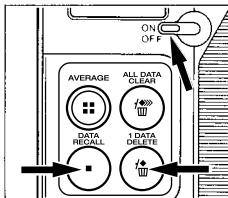

KONICA MINOLTA
SPAD-502 Plus
S/N: 91001873
VER: 1.000000



CHECK MODE



CALIBRATION CH

2. Perform calibration. With no sample in the sample slot, press on the finger rest to close the measuring head and hold it closed until a beep sounds and the display shown at right appears.

- If a series of beeps sounds and "ERROR" appears in the display, calibration was not performed correctly. Repeat step 2, making sure that calibration is performed correctly.

N=0 CH
— — — —
■

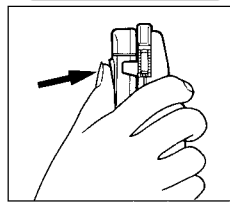

3. Remove the depth stop.

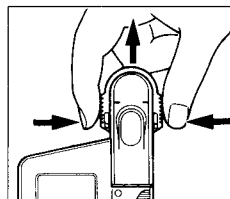

4. Insert the reading checker into the sample slot, press on the finger rest to close the measuring head, and hold it closed until a beep sounds and the measured value appears in the display.

- If a series of beeps sounds and "ERROR" appears in the display, measurement was not performed correctly. Repeat step 4, making sure that measurement is performed correctly.

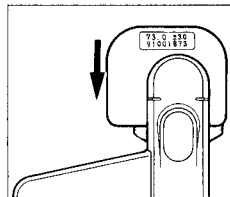

5. Repeat step 4 several times with the reading checker inserted in the sample slot.
6. Press **AVERAGE** to calculate the average value of the measurements. The displayed average value should be within the range shown on the reading checker. If it is not within this range, clean the emitting and receiving windows and repeat the above procedure starting with step 1. If the average value is still not within the range shown on the reading checker, the meter may be malfunctioning. Contact the service center.

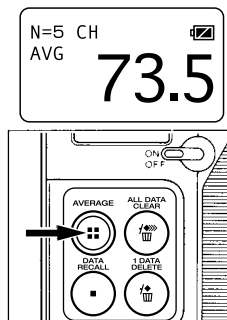

Acceptable range

7. To resume normal operation, turn the power switch to **OFF** and then to **ON** again.
 - The reading checker should be used only in check mode. Measuring the reading checker in measurement mode may give inaccurate values.
 - Only the reading checker included with the unit (and having the same serial number as the unit) should be used. Other reading checkers may not give accurate values.
 - The reading checker should not be used outdoors. When using indoors, do not use in direct sunlight or in areas subject to high temperatures or high humidity.
 - Differences between the measured value of the reading checker and the value shown on the reading checker should not be corrected for by inputting a compensation value.
 - Do not touch the glass surface of the reading checker. If it becomes dirty, wipe it with a soft, clean, damp cloth.
 - To protect the reading checker, it should always be stored in the accessory case. Do not store it in areas subject to high temperatures or high humidity.

TROUBLESHOOTING GUIDE

If a problem occurs with the SPAD-502Plus, use the following troubleshooting guide to try to solve the problem yourself. If the problem cannot be solved according to the troubleshooting guide, call the service center.

Problem	Checkpoint	Solution
Power switch is at ON , but display is blank.	Are batteries installed correctly?	Install batteries correctly (see p. 6).
	Are batteries “dead” ?	Replace batteries with fresh ones.
Measurements cannot be taken even if the measuring head is closed.	Did you perform calibration by closing the measuring head with no sample in the sample slot?	Perform calibration according to the procedure on p. 7.
Measured values disappeared from memory.	Did you turn the power switch to OFF ?	Memory is erased when the power switch is turned to OFF .
The measured value varies even though the same area of the leaf is measured.	Is there a drop of water or a stain on or near the emitting or receiving windows of the measuring head?	Wipe the emitting and receiving windows of the measuring head with a clean, soft, dry cloth.
	Is the sample leaf positioned correctly?	Position the sample leaf so that it is under the center line and completely covers the receiving window.
	Does the leaf have many veins?	When measuring leaves with many veins, the measured value may vary due to the veins. For best results, measure several areas of the same leaf and use the average value of these measurements.
	Are you closing the measuring head correctly and keeping it completely closed until measurement is complete?	Close measuring head correctly and keep it completely closed until measurement is complete (until a beep sounds and the measured value appears in the display).
	Are you measuring under direct sunlight?	When measuring in direct sunlight, shade the SPAD-502Plus with your body to prevent the sunlight from affecting measurements.

CARE AND STORAGE

- The SPAD-502Plus is water-resistant. However, do not immerse it in water or wash it with water. If it gets wet, wipe it dry after use.
- Do not subject the meter to strong shock or vibration.
- Do not press on or damage the LCD window or measuring head.
- Do not leave the meter in direct sunlight or near sources of heat, such as stoves, strong lights, etc.
- Turn the power switch to **OFF** when the meter is not being used.
- When dirty, the meter may be wiped with a soft, clean, dry cloth. If the meter is extremely dirty, use a damp cloth to wipe off most of the dirt and then wipe the meter dry with soft, clean, dry cloth. Do not allow alcohol or chemicals to touch the meter's surface.
- Never attempt to disassemble the meter. If the meter malfunctions, contact the service center.
- The meter should be stored at temperatures between – 20 and + 55°C. Do not store the meter in places subject to high temperatures or high humidity, such as inside a closed motor vehicle. It should be stored with a dehumidifying agent. if possible, the temperature should be kept relatively constant during storage.
- When the meter is to be stored for more than two weeks, remove the batteries from the meter body.

MEASURING PRINCIPLE

The values measured by the Chlorophyll Meter SPAD-502Plus correspond to the amount of chlorophyll present in the plant leaf. The values are calculated based on the amount of light transmitted by the leaf in two wavelength regions in which the absorbance of chlorophyll is different.

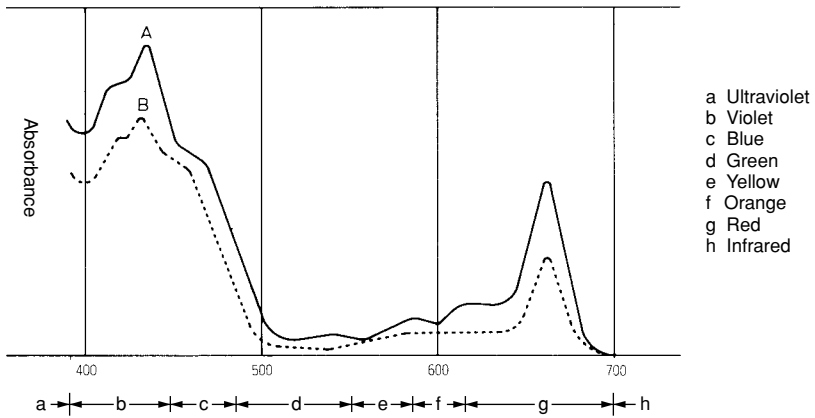

Figure 1: Spectral absorbance characteristics of chlorophyll

Figure 1 shows the spectral absorbance characteristics of chlorophyll extracted from two leaves using 80% acetone. The chlorophyll content of leaf B is less than that of leaf A. The graph also shows that the peak absorbance areas of chlorophyll are in the blue and red regions, with low absorbance in the green region and almost no absorbance in the infrared region. Based on this, the wavelength ranges chosen to be used for measurement are the red area (where absorbance is high and unaffected by carotene) and the infrared area (where absorbance is extremely low).

A block diagram of the Chlorophyll Meter SPAD-502Plus is shown in Figure 2.

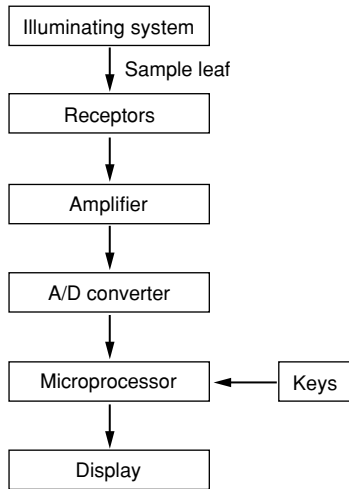

Figure 2: Block diagram of the SPAD-502Plus

LEDs in the illuminating system emit red and infrared light. The light which passes through the sample leaf strikes the receptor, which converts the transmitted light to analog electrical signals. These analog signals are boosted by the amplifier and are then converted into digital signals by the A/D converter. The digital signals are then used by the microprocessor to calculate the SPAD value, which is shown in the display and also automatically stored in memory. Data in memory can then be recalled or deleted and the average value of all data in memory can be calculated by pressing the appropriate key.

Illuminating/Measuring System

Two LEDs, a red LED (peak wavelength: approx. 650nm) and an infrared LED (peak wavelength: approx. 940nm), provide illumination. The relative illuminance provided by these LEDs is shown in Figure 3 below.

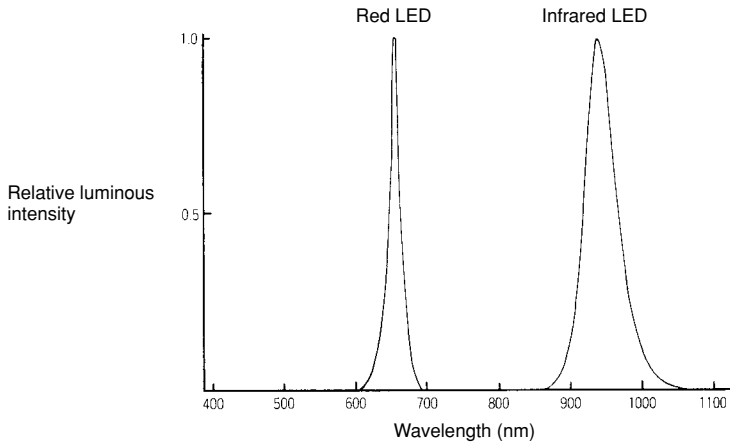

Figure 3: LED luminous intensity characteristics

The two LEDs are built into the measuring head (Figure 4) and emit light in sequence when the measuring head is closed. Light from these LEDs goes through the emitting window, passes through the sample leaf in the measuring head, and enters the receiving window. It then strikes the SPD (silicon photodiode) receptor and is converted into analog electrical signals.

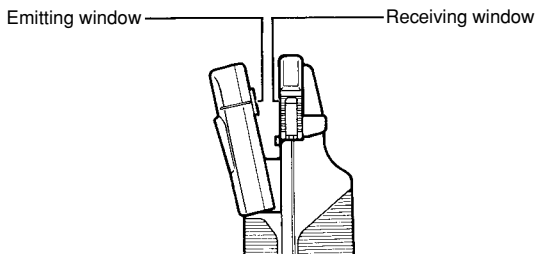

Figure 4: Illuminating/measuring system of the SPAD-502Plus

Calculations

Calculation of the SPAD value is performed according to the following procedure.

1. During calibration, the two LEDs emit light sequentially without any sample in the sample slot. The received light is converted into electrical signals and the ratio of their intensities is calculated.
2. After a sample has been inserted in the measuring head, the two LEDs emit light again. The light transmitted by the leaf strikes the receptor and is converted into electrical signals. Then the ratio of the intensities of the transmitted light is calculated.
3. The values obtained in steps 1 and 2 are processed to calculate the SPAD value, which corresponds to the amount of chlorophyll present in the sample leaf.

TECHNICAL DETAILS

Type:	Handheld meter for measuring chlorophyll
Measurement sample:	Plant leaves
Measurement principle:	Optical density difference at two wavelengths
Measurement area:	2mm x 3mm
Maximum sample thickness:	1.2mm
Insertion depth:	12mm maximum; depth stop adjustable to depths between 0 and 6mm
Light source:	2 LEDs (light-emitting diodes)
Receptor:	1 SPD (silicon photodiode)
Display:	LCD panel showing 4-digit measurement value (-9.9 to 199.9) and 2-digit data number
Data memory:	Space for 30 data
Controls:	Power switch: Switches power on and off AVERAGE Key: Calculates the average of all data in memory ALL DATA CLEAR Key: Deletes all data in memory DATA RECALL Key: Recalls data graphically for previous data number 1 DATA DELETE Key: Deletes displayed data Measurements automatically taken when measuring head is closed.
Power source:	2 AA-size 1.5V alkaline-manganese
Battery life:	More than 20,000 measurements per set of 2 alkaline-manganese batteries
Minimum interval between measurements:	Less than 2 seconds
Accuracy:	Within ± 1 SPAD* unit (at room temperature, SPAD* value between 0 and 50.0); SPAD* values of greater than 50.0 may be less accurate and will cause “ * ” to appear.
Repeatability:	Within ± 0.3 SPAD* units (SPAD* value between 0 and 50.0)
Reproducibility:	Within ± 0.5 SPAD* units (SPAD* value between 0 and 50.0)
Temperature drift:	Less than ± 0.04 SPAD* units/ °C
Operating Condition:	0 to 50°C (32 to 122°F) relative humidity less than 85% at 35°C with no condensation.
Storage Condition:	-20 to 55°C (-4 to 131°F) relative humidity less than 85% at 35°C with no condensation.
Other:	Buzzer (single beep for measurement complete, series of beeps for error); function for inputting compensation value
Dimensions (L x W x D):	164 x 78 x 49mm
Weight:	200g (without batteries)
Standard accessories:	Sliding depth stop; carrying strap; soft case; 2 AA-size batteries; reading checker

*SPAD values are values defined by Konica Minolta which indicate the relative amount of chlorophyll present in plant leaves. Specifications subject to change without notice



KONICA MINOLTA