

FieldScout® TDR 150 Soil Moisture Meter Product Manual

Item #6445



GENERAL OVERVIEW

Thank you for purchasing a FieldScout TDR 150 soil moisture meter. This manual describes the meter's general features and operations.

Soil moisture is a critical, and potentially highly valuable component of the soil environment. Time domain reflectometry (TDR) is a proven technology for quickly and accurately determining volumetric water content (VWC) in soil. Electrical conductivity (EC) is a function of the moisture and salt in the soil and can be factored out to increase the accuracy of VWC measurements. The meter also measures soil surface temperature. The user can quickly transition between taking VWC readings in standard, high-clay or sand-based soils.

The meter's built-in data logger eliminates the need to record data manually. The data points can be viewed with the FieldScout Mobile app that maps out soil measurements using logged location coordinates. Measurements can also be saved to a USB flash drive using the built-in USB port. Note: Meters sold on or after 1/1/2024 have Bluetooth and GNSS included. Meters purchased prior to 1/1/2024 can be upgraded to include Bluetooth and GNSS by ordering item #6445GBU.

Includes the Following Components:

- TDR 150 Meter
- Carrying Case
- 4 AA Batteries (already installed)

Note: **TDR rods are sold separately**

TABLE OF CONTENTS

General Overview.....	2
Product Details.....	3-5
Setup.....	6-8
Operation.....	9-10
Data Logging & Measurements.....	10-12
Maintenance.....	12-13
Updating & Calibration.....	13-15

This manual will familiarize you with the features and operation of your new FieldScout TDR 150 Soil Moisture Meter. Please read this manual thoroughly before launching the unit.

For customer support or to place an order, call Spectrum Technologies, Inc. at 800-248-8873 or 815-436-4440, FAX at 815-436-4460, or e-mail at info@specmeters.com.

www.specmeters.com
Spectrum Technologies, Inc.
3600 Thayer Court
Aurora, IL 60504

PRODUCT DETAILS

Specifications

Characteristic	Description
Power	4 AA Batteries (included)
Weight	1.5 lb (0.7 kg)
Log Capacity	50,000 Measurements
Display	Backlit, High-Contrast, Graphic LCD
IP Rating	Display: IP53, Probe: IP67
Connectivity	USB Type A, Bluetooth Low Energy
GNSS* Supported Systems	Galileo, GLONASS, GPS, QZSS (where available), EGNOS, MSAS, SBAS and WAAS enabled Accuracy: <2.5m Typical, <10m (initial)
Probe Head Dimensions	2.4" x 1.4" (6cm x 3.5cm)
Measurement Units	% Volumetric Water Content (VWC) Period (raw sensor reading) Electrical Conductivity (EC) in milliSiemens per centimeter
Resolution, Accuracy & Range	VWC: 0.1% increment $\pm 3.0\%$ @ <2 mS/cm 0% to Saturation (Saturation is typically around 50% volumetric water) EC: 0.01 increment; ± 0.1 mS/cm; 0-5.5 range Temperature: 0.2°F (0.1°C) increment; $\pm 1.8^\circ\text{F}$ ($\pm 1^\circ\text{C}$); -22°F to 140°F (-30°C to 60°C) Thermistor based; Infrared Optional
Available Rod Dimensions	Turf..... 1.5" (3.8cm) Short..... 3.0" (7.6cm) Medium..... 4.8" (12.2cm) Long..... 8.0" (20.32cm) Diameter..... 0.2" (0.5cm) Spacing..... 1.25" (3.18cm)

Product Dimensions

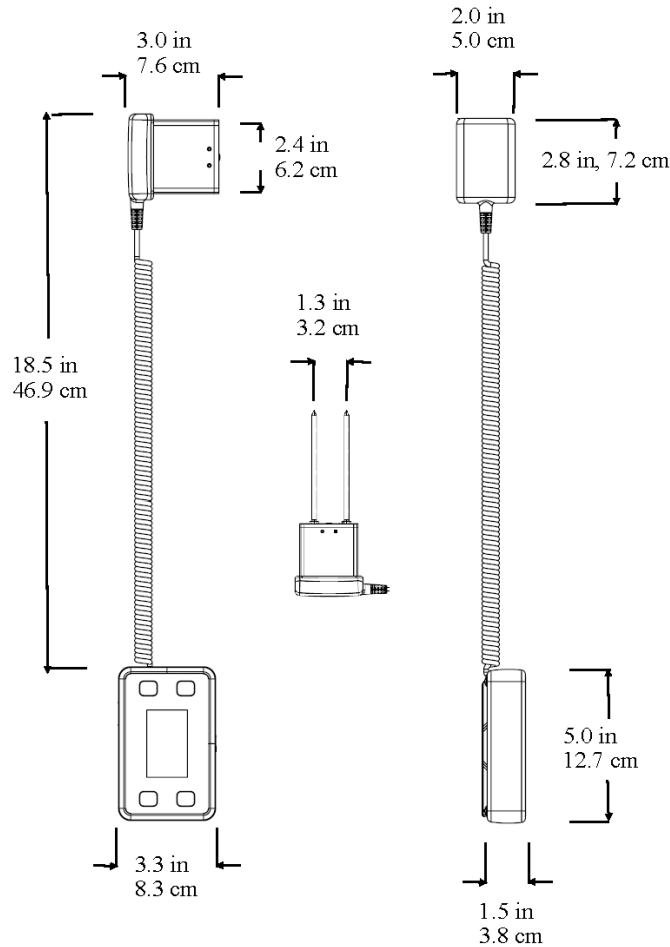

Display Screens

The TDR 150 has 3 main display screens:

- Startup
- Reading
- Settings Menu

Note: An upgrade is required to access GNSS and Bluetooth features.

Startup Information Screen

Initially displayed after powered on

- Displays model, serial number and firmware version
- Press and hold **ON/OFF|BACK** button remain on this screen

Reading Screen

Displays the last measurements, EC in mS/cm and temperature as well as selected rod type, selected soil type and a reading count with running average. VWC=0% readings will be displayed but will not increase the counter or be included in the average.

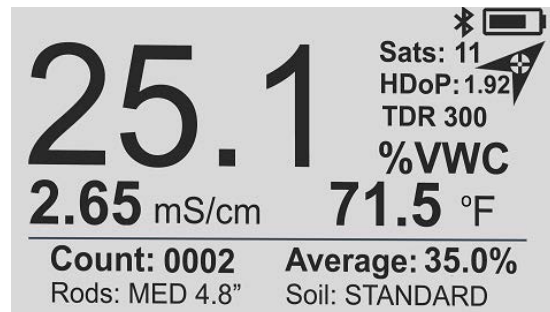

Settings Menu Screen

Used for changing device features, setting rod length and working with log files

Use the arrow buttons to move to the desired option

Use the **MENU|SELECT** button toggle to through option choices

Clear Average*: Clears the display average and count

Note: Same as pressing and holding the **READ|Down** arrow button

Rod Length: Select the Rod length

Soil Type: Selects soil type used in measurements:

- **Standard**: for most soil types
- **Hi-Clay**: for soils with higher clay content (> 27%)
- **Sand**: for sand based fields or turf greens

Clear Logs*: Erases data logs from internal memory

Save to USB*: Transfers data logs to a USB flash drive if attached

Backlight: Sets the LCD backlight: ON, OFF, AUTO. In AUTO mode, the backlight will shut off 5 seconds after button press

Sound: Enable or disable beep for audible feedback

GNSS Location, GNSS Power Save, GNSS Use QZSS: Enable or disable features related to geolocation capability

Bluetooth: Enable or disable Bluetooth connectivity to the FieldScout Mobile App

Temp Source: Changes displayed temperature from the Soil Sensor to the IR Sensor (optional)

Temp Units: Fahrenheit or Celsius scale

EC Units: EC value (mS/cm) or Salinity Index

Moisture Type:

- VWC%: Volumetric Water Content with EC compensation
- Period: Raw sensor reading in microseconds (US)
- TDR 300: VWC% without EC compensation

Auto-Off: Power off delay (15, 30, 45, 60 minutes)

Current Date, Current Time: Set/display the current time and date values

Time Zone: Offset from Greenwich Mean Time, as the offset changes, the Time and Date will update

Daylight Savings: ON or OFF

Calibration*: Overrides factory calibration

Clear User Calibration: Clears the user applied calibration back to factory settings

Factory Defaults*: Resets menu settings and counter to the factory default value

**Pressing Select button for these options brings up additional screen*

About: General information (model and serial number, firmware versions for display and sensor)

Defaults:

Rod Length	Not Set	Moisture Type	VWC
Soil Type	Standard	EC Units	mS/cm
Sound	ON	Auto-Off	15 minutes
Backlight, GNSS, BT	Disabled	Time Zone	GMT
Temperature	Fahrenheit	Temp Source	Soil Sensor

Optional Accessories

There are optional items that can be used to expand the capabilities of the TDR150. Visit www.specmeters.com for more information and installation instructions.

Infrared Temperature Sensor (Item 6435TS)

Provides an instantaneous and highly accurate temperature reading as an alternative to the existing surface temperature.

TDR Spacer (Item 6435SP)

- Placed on the end of the sensor block to aid in identification of how fast and firm the turf greens are. The spacer has two orientations allowing it to work for either desired depth
- Requires 1.5" (3.8cm) turf rods
- Allows for the measurements of 0.5" (1.3cm) or 1.0" (2.5cm) soil depths

Pilot Hole Maker (Item 6430PH)

If the ground is especially hard or compact, you can use a Pilot Hole maker to make 3" holes to aid in starting the insertion of the probe rods.

1-Year SpecConnect FieldScout Pro Subscription

Upload measurements to the cloud/web interface for real-time monitoring of field and turf conditions. Access historical data, trends and generate reports.

Item 3035A - for up to 3 devices

Item 3035B - for up to 7 devices

Item 3035C - for 8 or more devices

GNSS Location/FieldScout Connectivity

GNSS and Bluetooth capability are not standard features for TDR150 meters sold prior to 2024.

SETUP

GNSS (Location) Settings

GNSS Location adds the ability to log global position coordinates with measurements to aid in irrigation mapping of crops and turf greens. Location references are stored with the measurement in the data log and can be uploaded to the Cloud through the SpecConnect FieldScout Mobile App option.

The following menu settings apply to and effect the GNSS location feature:

GNSS Location

Enabled: Measurements will include global position coordinates of the meter position in the data log and/or FieldScout App.

Disabled: No location coordinates appear in the Data Log. SpecConnect FieldScout app measurements will include the global position of the mobile device running the app.

GNSS Power Save

Enabled: After periods of inactivity, the GNSS receiver will be placed in standby to improve battery life. The receiver resumes after the next read button press. A brief pause may be noticed as the receiver resumes operation.

Disabled: GNSS receiver will remain on for faster measurements. It is recommended to keep disabled during the first few days of use to improve accuracy and mapping.

GNSS Use QZSS

Enabled (Default): Improves location accuracy in Australia, Bangalore, Guam, Hawaii, Japan, Singapore and surrounding areas.

Disabled: Can improve location referencing time when outside of the referenced regions.

GNSS Location: Features, Use and Operation

When enabled, the GNSS Location feature provides active location of referencing information to aid in measurement mapping.

HDoP: Actively transitions from a high to low value as the level of precision improves. It may increase in value if conditions degrade. Values typically range between 9.99 to as low as 0.2. The value will appear blank until satellites in range are received and precision is calculated.

Sats: Active number of satellites used for precision and location measurements. The value will increase from 00 as more satellites are received and used.

Location Reference Arrow Icon:

Transitions with changes in conditions, available satellites and higher levels of precision are reached.



Blank Icon - GNSS feature is enabled and not ready for location referencing of measurements. Measurements made with this icon will not have a georeferenced location.



Partially Shaded - HDoP level is high and the satellite count is low. Measurements will have georeferenced coordinates with a low level of accuracy (< 10m typical).



Dark Shaded - High satellite count without supplemental augmentation. Measurement location accuracy will depend on HDoP and Sats count.



Dark Shaded with Blank Dot - Low Satellite count with supplemental augmentation available to improve accuracy. Measurement location accuracy will depend on HDoP.



Dark Shaded with Crosshair - High satellite count with supplemental augmentation available to improve accuracy. Measurement location accuracy is optimal (< 2.5m) and will depend on HDoP.



Clock Icon (HDoP Z.zz) - GNSS Power Save has placed the receiver in standby mode. Press READ|Down button to resume.

Note: First reading will have a slight delay.

Initial Use:

During the first three days of use, the meter's GNSS receiver will build an internal satellite record used for tracking and accuracy. Accuracy during this time may appear low, will depend on the accuracy of available satellite systems, and can vary within 10 meters. After the third use, the satellites record will be complete; the speed and accuracy of the location referencing will be at its best as the record is synchronized with the area the meter is being used.

Preparing for Measurements:

Expect the first georeferenced location will take place within a minute or so of operation on a clear day. A minimum of 4 received satellites are necessary for a location fix. Achieving 10 or more satellites will yield better position data.

For Best Results:

- Keep the meter active for more than 6 minutes per session
- Avoid powering off the meter between measurement locations within a use session. The meter will acquire the most satellites and better position data when remaining on for longer periods of use
- Position the meter upright (probes facing down) while moving between locations to allow continued satellite tracking
- When positioning the meter for a measurement, observe the display for dark arrow icon, low HDOP value and high Sats number
- If possible, keep the meter stationary in position for a moment before pressing the read button
- For faster results, disable GNSS Power Save to keep the receiver active. When enabled and the meter has been inactive, GNSS receiver may take a few seconds to resume from standby
- Avoid using close to structures and dense tree canopies which can block satellite signals
- Adjust standing position to acquire best icon shading and satellite count prior to pressing the read button. Simply standing to the side of the meter may make satellites visible and change the count and precision

FieldScout Mobile App/SpecConnect

The FieldScout Mobile App can be used to view measurement results directly on your mobile device and send data directly to the SpecConnect web interface. Data can be viewed on a Smartphone in two formats:

Basic Grid Mode - Available with or without SpecConnect subscription. The site is divided into a customizable 2-dimensional grid of 3 to 5 rows and 3 to 5 columns. Measurements are taken in each grid cell. Grid cells are color-coded showing VWC average (Figure 1).

Freeform Mode - Available with SpecConnect subscription. Color-coded location icons are placed at every measurement point using the coordinates from the meter (Figure 2). If the meter's GNSS location is disabled or a blank arrow appears on the meter, the app will use the internal location of the app's mobile device.

The data from the Pro version of the app is sent instantaneously to SpecConnect. Data can be viewed in map form (Figure 3), exported to a spreadsheet, or viewed as a Trend Report (Figure 4). More details are available in the user's guide for the app.

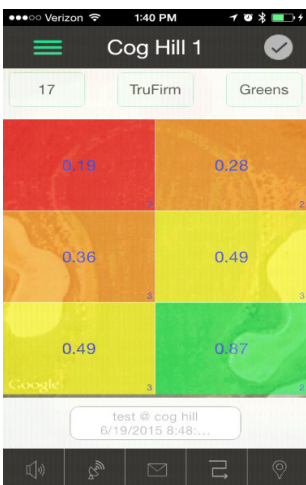
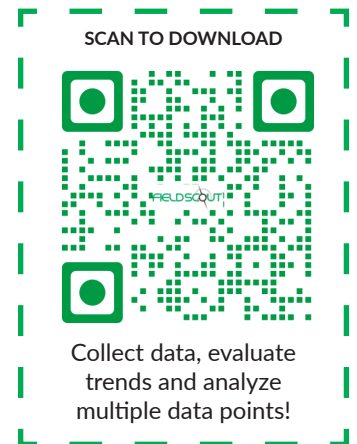

Figure 1 - Grid Mode



Figure 2 - Freeform Mode

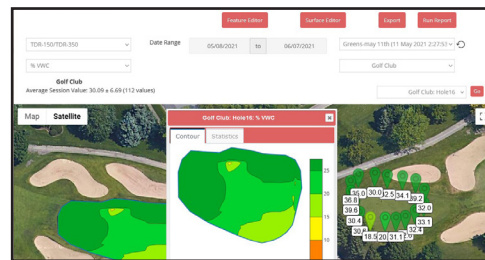

Figure 3 - 2-D Mapped Readings and Contour Plot in SpecConnect

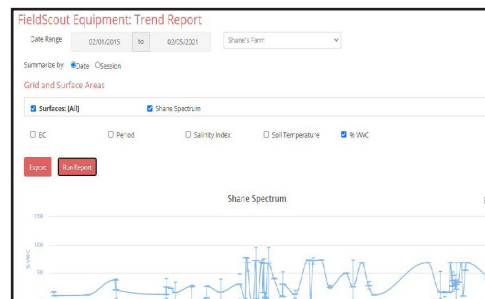

Figure 4 - Trend Report

FieldScout Mobile App: Set Up and Use

Bluetooth functionality requires an equipment upgrade for meters sold prior to 2024.

At any time, tap the app's menu icon to view or edit options.

1. Enable the TDR's Bluetooth and GNSS options
2. Open the FieldScout mobile app
3. Enter the SpecConnect username and password to send measurements to the cloud account or tap Use FieldScout Basic to start grid mode
4. During first use; tap the Golf or Agriculture icon
5. Add a Course/Farm or select an existing session
6. In Basic mode, the Grid screen appears. Tap on a grid cell where measurements will be added (Figure 5a)
7. In SpecConnect Freeform mode, the app will transition to the session screen (Figure 5b)
8. Tap the **Connect FieldScout Device via Bluetooth** button. If Bluetooth is not enabled on the mobile device, a prompt will appear to enable it
9. Select the TDR from the device list (Figure 6)

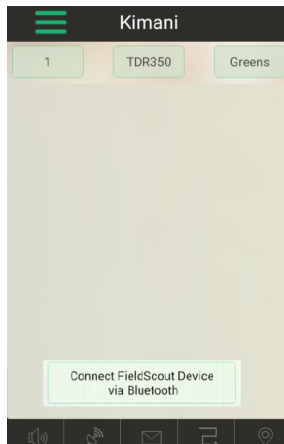

Figure 5a - Bluetooth Connect button (Grid)

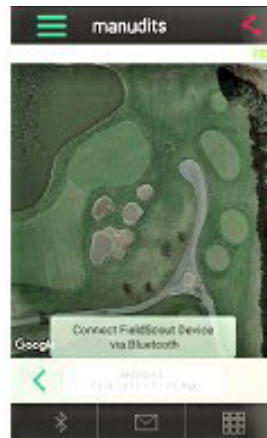

Figure 5b - Bluetooth Connect button (Freeform)

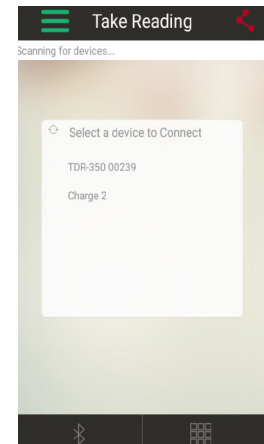

Figure 6 - Scanned Device List

10. Confirm that the meter you are using appears at the top of the screen. If you are in Grid mode, tap a zone (Figure 7)
11. Press the **READ** button on the TDR and the measurement data will appear on the mobile device

Note: Although the device appears in the app, it may not appear on the phone's list of Bluetooth devices

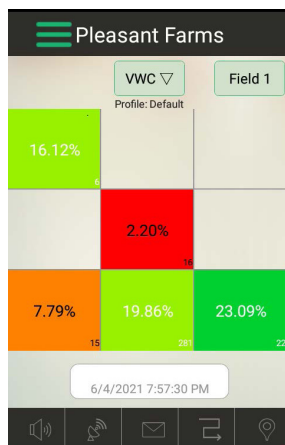

Figure 7a - Grid Mode

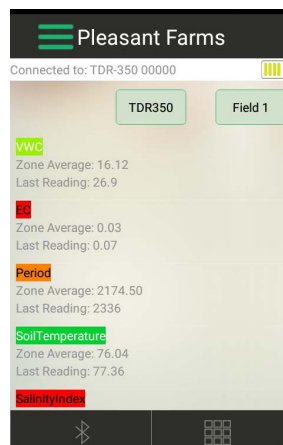

Figure 7b - Grid Mode List

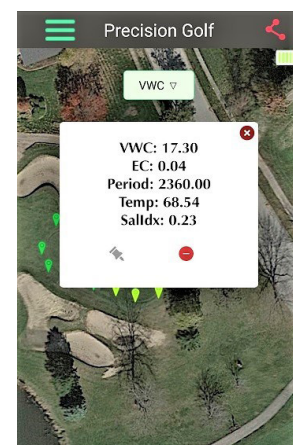
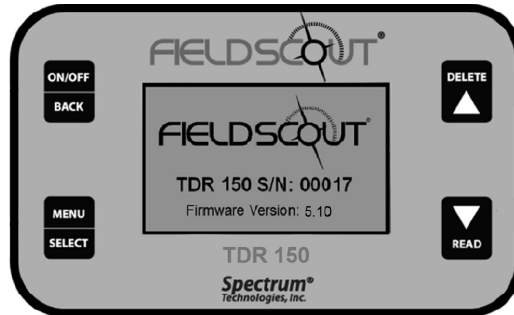

Figure 8 - Freeform List

OPERATIONS

Button Functions



ON/OFF|BACK Button

- Press briefly to power on
- Press and hold to power on and stay on the logo screen
- Press and hold for 2 seconds to power off
- Press within a menu to return to prior screen



MENU|SELECT Button

- Press to enter menus
- Press to select or confirm a menu selection



DELETE|UP Button

- Press to move up within a menu
- Delete last measurement from the running average, counter and its entry from the internal data log



READ|DOWN Button

- Press to move down within a menu
- Press **READ** to make a reading
- Press and hold to reset the average and count

Setting Date/Time

By default, the TDR150 gets the date and time from the satellite signal. These values are displayed in the Settings Menu. The date and time can also be set manually. When the time and date are set manually, they will over-ride the default value.

Note: When the batteries are removed, the date and time are reset and the meter resumes getting this information from the satellites

Updating the Date and Time

1. Press the **MENU|SELECT** button to enter the Settings Menu
2. Press the **UP/DOWN** arrow to navigate to either the **Current Date** or **Current Time** option
3. Press the **MENU|SELECT** button to access the Time/Date update screen
4. Press the **READ|DOWN** button to download and update from the GNSS satellites. Proceed to an area with a good view of the sky
5. Press the **MENU|SELECT** button to initiate the process
6. Press the **DELETE|UP** button to set the date and time. The current time for the time zone setting will be displayed
7. Use the **UP/DOWN** arrow to adjust the highlighted selection
8. Press the **MENU|SELECT** button to confirm the change and proceed to the next selection
9. After pressing the **MENU|SELECT** button to set the minutes, the display will return to the Reading screen
10. Press the **ON/OFF|BACK** button to return to the Settings Menu without making any change

Meter Operations

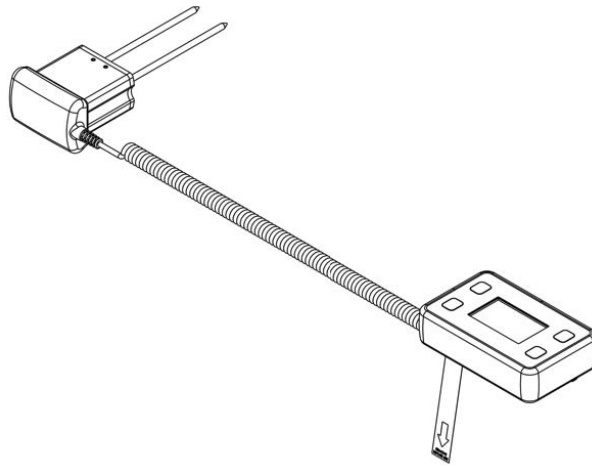

Setting Up the Meter

1. Pull the clear battery transport tab out of the display unit
2. Select a set of probe rods and screw them to the bottom of the probe block, tightening securely
3. Set the desired user settings in the settings menu

Taking Readings

1. Grip the TDR sensor block
2. Push down on the block maintaining a steady downward pressure to drive the rods into the soil until the sensor base is in contact with the soil surface. Refrain from any back and forth or side to side movement which can introduce air pockets into the soil medium which will alter the reading accuracy.
Caution: Exercise care not to bend or damage the rods
3. Press the **READ** button and observe the change in results on the top display

DATA LOGGING & MEASUREMENTS

Data Logs

Downloading Data Logs to a USB Flash Drive

1. Remove the protective dust cover from the USB port
2. Connect the flash drive directly to the meter's USB port
Note: Do not connect a USB cable as this may damage the TDR
3. Press the **MENU|SELECT** button to open the Settings Menu
4. Press the **READ|DOWN** arrow button to advance to the **Save to USB** option
5. Press the **MENU|SELECT** button to select the option
6. When the download completes, "Logs Saved!" will appear on the LCD screen
7. Remove the flash drive from the USB port and replace the dust cover

The data will be saved as a comma-separated text file (.csv) with the serial number as the file name. These files can be opened with common text-editing or spreadsheet software. If a previous data file exists on the flash drive with the same file name, it will be over-written. Be sure to backup any existing data logs on the flash drive prior to saving a new file.

Erasing the Internal Data Log

1. Press the **MENU|SELECT** button to open the Settings Menu
2. Press the **READ|DOWN** arrow button to advance to the **Clear Logs** option
3. Press the **MENU|SELECT** button to select the option
4. Press the **MENU|SELECT** button again to start the process or the **ON/OFF|BACK** button to return back to the menu

Data Collected

The following information is logged with each reading:

Time	MM/DD/YYYY HH:MM:SS based on the GMT offset selected in the Time Zone option
VWC%	Volumetric Water Content based on the Moisture Type setting - EC Compensated or "TDR 300" (without EC Compensation)
Period	Raw Period result (after any applied user calibration)
EC	Electrical Conductivity in milliSiemens per centimeter
Rod Length	Depicted as Long (L, 8"), Med (M, 4.8"), Short (S, 3"), Turf (T, 1.5"), 0.5" Spacer (1), 1.0" Spacer (2)
Soil Type	Depicted as Standard (S), Hi-Clay (H) or Sand (D)
VWC Mode	Depicted as EC Compensated (V) or TDR 300/non-compensated (3)
Temp_Soil	Soil temperature sensor reading in degrees Celsius
Temp_Soil (F)	Soil temperature sensor reading in degrees Fahrenheit
Temp_IR	InfraRed soil temperature sensor reading in degrees Celsius
Temp_IR (F)	InfraRed soil temperature sensor reading in degrees Fahrenheit
Latitude, Longitude	Georeferenced coordinate acquired in decimal degrees format. <i>Note: A negative sign may appear indicating South or West coordinates</i>
Satellites	Number of satellites used in georeferenced location
Fix	GNSS location fix level: 0 - unreferenced, 1 - fixed reference, 2 - fix with additional accuracy correlation (SBAS, WAAS, EGNOS)
HDoP	Horizontal Dilution of Precision value achieved with the GNSS coordinates

VWC Measurements

Volumetric Water Content (VWC)

The ratio of the volume of water in a given volume of soil to the total soil volume expressed as a decimal or percentage. Four soil moisture levels of most importance can be defined as follows:

Saturation: All soil pores are filled with water. The VWC will equal the percent pore space of the soil.

Field Capacity: The condition that exists after a saturated soil is allowed to drain to a point where the pull of gravity is no longer able to remove any additional water.

Permanent Wilting Point: The highest moisture content at which a plant can no longer extract water from the soil.

Plant Available Water: the amount of water between Permanent Wilting Point and Field Capacity. Irrigation should be initiated when half the Plant Available Water has been depleted.

Time Domain Reflectometry (TDR)

The speed of an electromagnetic wave along a waveguide in soil is dependent on the bulk dielectric permittivity (ϵ) of the soil matrix. The fact that water ($\epsilon = 80$) has a much greater dielectric constant than air ($\epsilon = 1$) or soil solids ($\epsilon = 3-7$) is exploited to determine the VWC of the soil. The VWC measured by the TDR is an average over the length of the waveguide.

The sampling volume is an elliptical cylinder that extends approximately 3cm out from the rods. The high frequency signal information is then converted to volumetric water content. High amounts of clay or high electrical conductivity ($EC > 2$ mS/cm) will attenuate the high-frequency signal and affect the reading displayed by the meter. Very high organic matter content will similarly affect the VWC reading.

Electrical Conductivity

The FieldScout TDR uses EC readings obtained from the same probes used to measure VWC. To improve the VWC measurement accuracy, EC is factored out of the VWC reading. This is a key advantage over its predecessor. The value measured is an advantage for the entire depth sampled. EC is expressed in units of mS/cm. The EC measured by an electrode is defined as the bulk EC.

The salinity level of soil is an important component of irrigation and nutrient management. The source of soil salts range from the original patent material, additions from natural sources and management activity. High salt concentration in the soil has a negative effect as plant roots cannot bring in sufficient soil moisture, However, fertilizer exists as salt ions in that same soil solution. Low salt level can result in plants not getting the nutrients needed.

Direct measurement of salt content can only be done by subjecting a field sample to laboratory analysis. Fortunately, the electrical conductivity (EC) is a function of the dissolved salts in the soil. This proxy measurement is possible because, as salts dissolve into the soil, they disassociate into ions which conduct electricity.

Salinity Index

The TDR also has the option to report EC in the form of the Salinity Index. The salinity index is defined as the ratio of the bulk EC to the volumetric water content (expressed as a decimal). For example, if the bulk EC is 0.25 mS/cm and the VWC is 22%, the Salinity Index would be reported as 1.14 ($0.25 / 0.22 = 1.14$). Therefore, the Salinity Index combines VWC and EC (corrected for temperature) into a parameter that will be less dependent on the sub-saturated water content.

The TDR measures the bulk EC of soil that may or may not be saturated. As the soil dries, the remaining pore space solution becomes more concentrated which increases EC. However, reduced water in the pores leads to a longer and more tortuous path between the sensor electrodes, which decreases EC. The second mechanism dominates. Bulk EC will decrease as soil moisture decreases. EC measurements made at different times are comparable when the moisture content is the same. This is best observed if the readings are always taken when the site is at field capacity - when a saturated soil is allowed to drain to the point where the pull of gravity can no longer remove any additional water.

MAINTENANCE

Meter Care

The FieldScout TDR meter will function properly under normal conditions experienced in field use. The sensor block is sealed and will not be damaged by immersion in water. The display is **NOT** waterproof. The meter should not be used during heavy rainfall or left exposed during irrigation events. If the display does get wet, it should be dried out immediately.

Follow these tips to prolong the life of the device:

- Store in a cool and dry place when not in use
- Keep the meter and probe rods clean and dry in between uses
- Remove the batteries if not used for an extended period of time (i.e. between seasons)

Battery Life

If the battery level is low or a battery is inserted incorrectly, the low battery icon appears on the screen and the display will power off. Battery life is affected by the enabled features and frequency of use. If not needed, Bluetooth*, GNSS Location* and backlight features can be disabled individually to increase the battery life. The backlight can also be set to AUTO mode which illuminates the LCD screen when a button is pressed allowing time to view the screen then will switch off the backlight to prolong the battery life.

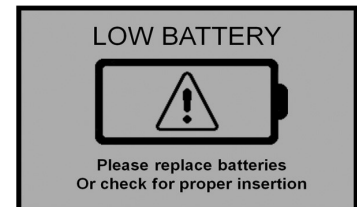

*GNSS and Bluetooth functionality is an optional equipment upgrade for meters sold prior to 2024.

Sensor Block Reattachment/Replacement (Item 6445S)

1. Flip the display so the backing plate is facing up
2. Remove the 4 screws on the base using a Phillips screwdriver
3. Lift off the base plate, observing the original orientation of the cable
4. Remove and set aside the foam insert behind the cable
5. Grip the cable connection and gently pull the cable out
6. Connect replacement sensor cable into the connection
7. Reinsert the foam insert behind the cable as shown
8. Guide the sensor cable through the open slot on the base plate
9. Secure the base plate screws with a Phillips screwdriver



Sensor cable, batteries and foam insert



Sensor cable fed through the slot

Battery Replacement

1. Flip the display so the backing plate is facing up
2. Remove the 4 screws on the base using a Phillips screwdriver
3. Lift off the base plate, observing the original orientation of the cable
4. Install four new AA batteries observing correct polarity by referencing the positive (+) and negative (-) labels
5. Guide the sensor cable through the open slot on the base plate
6. Secure the base plate screws with a Phillips screwdriver

Do not permanently remove the foam plug. It ensures the plug does not become detached.

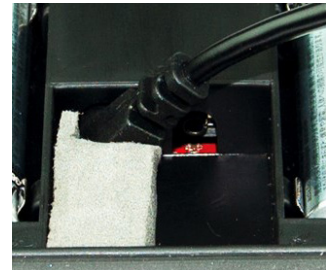

UPDATING & CALIBRATION

Updating Device Firmware

Firmware updates may be made available to add or improve the product features. The firmware can be updated using a USB flash drive. Firmware update files can be found on the Spectrum website.

1. Copy the latest firmware update from your PC onto the root directory of the flash drive. The file will not be seen by the meter if it is renamed or stored within a folder on the drive.
2. Power off the meter
3. Remove the protective cap from the meter's USB port
4. Insert the flash drive directly into the meter's USB port. Do not connect a USB cable as this may damage the TDR.
5. While pressing the **DELETE|UP** arrow button, press and release the **ON/OFF|BACK** button. The meter will beep.
6. Release the buttons

Note: The display screen will remain blank during the update process. The meter will beep a second time once the process has completed and then reboot to the logo screen. The new firmware will now be displayed below the Spectrum logo.

7. The display will alert the user if further updates are to be made and show a message when completed
8. Remove the flash drive and replace the USB port cover

Soil-Specific Reading Correlation

Improve accuracy and correlate TDR period readings with a soil-specific sample set. VWC data can be correlated by measuring the weight of a known volume of saturated soil as it is gradually dried, by gradually wetting a known soil with measured increments of water or by using a neutron probe. In most cases, gravimetric sampling is performed. This procedure is briefly described below.

1. Establish a number of field sites to sample
2. Wet each site with varying amounts of water
3. Obtain FieldScout TDR period reading at each sample site
4. Extract an undisturbed soil core at each sample site. Store samples in a sealed plastic container to reduce evaporation
5. Weigh the wet soil samples
6. Dry the samples (105°C for 48 hours) and weigh again
7. Plot sample measurements against FieldScout TDR readings

Regression analysis is used to develop a formula to correlate TDR reading to the sample data

Volumetric Water Content Calculations:

$$VWC = 100 * (M_{wet} - M_{dry}) / (p_w * V_{tot})$$

Gravimetric Water Constant Calculations:

$$VWC = GWC * (p_b / p_w)$$

$$GWC = 100 * (M_{wet} - M_{dry}) / M_{dry}$$

$$p_b = M_{dry} / V_{tot}$$

Where:

M_{wet} M_{dry} = mass (g) of wet and dry soil respectively

V_{tot} = total soil volume (ml)

p_w = density of water (1 g/ml)

Calibration

The FieldScout TDR is fully calibrated at the factory. Further calibration is not required, nor recommended. The meter has internal calibrations that will work for many soil types. Each meter will have a small difference in how it responds to identical soil conditions. This can be due to air being introduced while measuring, bent probes, loose probes, sensor drift or component tolerances. The meter allows for adjustments to the calibration to account for these differences. Should the user prefer to perform the calibration, the following are required:

1. A clean glass or plastic container. The container must be at least 4" (10cm) wide and 2" (5.08cm) longer than the length of the TDR rods.
2. A sufficient volume of unused distilled or de-ionized water to fill the above container

Note: Well or municipal tap water cannot be substituted

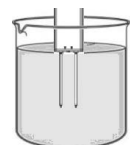

Procedure:

1. Pour all the distilled/de-ionized water into the container
Note: The water and container must be free of minerals and salts to calibrate properly
2. From the Settings Menu, set the rod length to the correct length of the rods currently installed
3. From the Settings Menu, choose the Calibration option
4. Press the **MENU|SELECT** button to initiate the calibration process. Follow the display messages.
5. While keeping objects and personnel clear from the area; raise the meter so the rods are in the air. Press the **MENU|SELECT** button and wait until the meter indicates it is ready.
6. Immerse the rods completely in the distilled/de-ionized water until the sensor base is in contact with the liquid. Keep the sensor base and rods centered in the container. Do not submerge the sensor base.
7. Press the **MENU|SELECT** button and wait until the meter indicates it is ready.
The meter will then show that the calibration is complete for that specific rod length. If more than one rod size is being used, a calibration operation must be done for each rod length used.

Troubleshooting

Verifying Operation:

The meter should read a measurement of 0% VWC with clean rods raised in the air. Test measurements should be made using distilled water, not well or municipal tap water, in a container at least 4" (10cm) wide and deep enough to submerge the full length of the sensor rods up to the sensor base. Measurements in water will not read 100% as the equations were set for typical water content of the soil type used.

Typical VWC range in water using VWC% mode and standard settings:

Rod Length	8" (20.3cm)	4.8" (12.2cm)	3" (7.6cm)	1.5" (3.8cm)
VWC %	60 - 65	70 - 75	75 - 80	65 - 70

Unable to save data to or load firmware from a USB flash drive:

Confirm the drive is not full or write protected. Verify the drive has FAT or FAT32 format. Firmware should be in the root directory, outside of any folders.

"Sensor Not Detected" appears on the display:

Communication lost between the sensor and display. The connection may be dirty, unplugged, or broken. Check the cable condition, clean the connection and reset. Power the meter off and then back on to reset.

"No Sensor" appears on the display:

Sensor unplugged from the display. Be sure to keep the foam insert behind the cable to retain the cable during battery changes. Reconnect the sensor, power off the meter and then back on to reset.

Clock icon appears on the display:

Unable to download the date/time. May also appear with "Zzz" when the GNSS Receiver is in standby.

GNSS/Bluetooth Capabilities

The TDR 150 meter comes with the GNSS and Bluetooth capability activated on meters sold on or after 1/1/2024. Meters purchased prior to 1/1/2024 can be upgraded by ordering item #6445GBU.

WARRANTY

This product is warranted to be free from defects in material or workmanship for two years from the date of purchase. During the warranty period Spectrum will, at its option, either repair or replace products that prove to be defective. This warranty does not cover damage due to improper installation or use, lightning, negligence, accident, unauthorized modifications, or to incidental or consequential damages beyond the Spectrum product. Before returning a failed unit, you must obtain a Returned Materials Authorization (RMA) from Spectrum. Spectrum is not responsible for any package that is returned without a valid RMA number or for the loss of the package by any shipping company.



Spectrum Technologies, Inc.
"To Measure Is To Know"



www.specmeters.com

RE-D EU Declaration of Conformity (DoC) #20210118_1
In accordance with European Parliament and Council Decision No. 768/2008/EC Annex III we, Spectrum Technologies, Inc., a corporation validly organized and existing under the laws of the United States of America, having its principal place of business at 3600 Thayer Court, Aurora IL 60504 USA, **declare under our sole responsibility that the below named**

Product: FieldScout TDR Soil Moisture Meter
Model Name (Product Number): TDR-150 (6445), TDR-250 (6250), and TDR-350 (6435)

Object of the Declaration:
FieldScout TDR Soil Moisture Meter providing a means for determining the volumetric water content (VWC) of a growing soil.
Specifications:

- Battery powered device (4 x AA batteries)
- 6.9cm (2.7") Backlit LCD Display
- Durable powder coated aluminum frame (TDR-250 and TDR-350)
- Hand-held Display UI and tethered sensor (TDR-150)
- Removable / Interchangeable sensing rods required for proper operation

to which this declaration relates, conform with the relevant requirements of the Harmonized Legislations mentioned below. Specifically, but not limited, to the following harmonized standards and/or normative documents:

Harmonization Legislation:
2014/53/EU Radio Equipment Directive
2011/65/EU Restriction of Hazardous Substances Directive

Article 3.1(a) Safety of Information Technology Equipment
2009 + A1:2010 + A12:2011 + A2:2013 (as applied to internal Bluetooth module Silicon Labs BGM113A-V1 or BGM13P where used)
1 edition + Am 1:2009 + Am 2:2013 (as applied to internal GNSS module Antenna Ltd. M20050-1 where used)

Spectrum Technologies, Inc.
"To Measure Is To Know"

Article 3.1(b) Electromagnetic Compatibility
EN 61000-6-1:2007 Immunity for residential, commercial, and light-industrial environments
EN 61000-6-3:2007 /A1:2011 Emission standard for residential, commercial, and light-industrial environments
EN 55032:2015 /A11:2020 Electromagnetic compatibility of multimedia equipment - Emission requirements
EN 301 489-1 V2.1.1 EMC standard for radio equipment and services; Part 1 (as applied to internal Bluetooth module Silicon Labs BGM113A-V1 or BGM13P and GNSS module Antenna Ltd. M20050-1 where used)
EN 301 489-1 V2.2.3; 2019-11 EMC standard for radio equipment and services; Part 1: Common technical requirements
EN 301 489-3 V2.1.1; 2019-03 EMC standard for radio equipment and services; Part 3: Specific conditions for Short-Range Devices
EN 301 489-17 v3.1.1 EMC standard for radio equipment and services; Part 17 (as applied to internal Bluetooth module Silicon Labs BGM113A-V1 or BGM13P where used)
EN 301 489-17 V3.2.4; 2020-09 EMC standard for radio equipment and services; Part 17: Specific conditions for Broadband Data Transmission Systems
EN 301 489-19 V2.1.1; 2019-04 EMC standard for radio equipment and services; Part 19: ... GNSS receivers operating in the RNSS band providing positioning, navigation, and timing data (as applied to internal GNSS module Antenna Ltd. M20050-1 where used)
EN 303 413 V1.1.1.1:2017 Global Navigation Satellite System (GNSS) receivers (as applied to internal GNSS module Antenna Ltd. M20050-1 where used)

Article 3.2 Spectrum Efficiency
EN 300 328 V2.1.1; 2016-11 Wideband Data Transmission Systems; 2.4 GHz Band; Emissions; EMC (as applied to internal Bluetooth module Silicon Labs BGM113A-V1 or BGM13P where used)
EN 300 440 V2.2.1: 2018-07 Short Range Devices 1-40 GHz; Emissions; EMC
EN 303 413 V1.1.1.1: 2017 Satellite Earth Stations and Systems; Global Navigation Satellite System (GNSS) receivers; (as applied to internal GNSS module Antenna Ltd. M20050-1 where used)

Article 3.3 Other Requirements
EN 63000:2018 Technical documentation for the assessment of electrical and electronic products with respect to the restriction of hazardous substances

Robert T Benesh
Robert T Benesh
Job Title: Electronics Engineer, TDR Product Manager
Email: rbenesh@specmeters.com



Spectrum Technologies, Inc.
"To Measure Is To Know"



www.specmeters.com

UK Declaration of Conformity (DoC) #20210118_2
In accordance with BS EN ISO/IEC 17050-1:2010 we, Spectrum Technologies, Inc., a corporation validly organized and existing under the laws of the United States of America, having its principal place of business at 3600 Thayer Court, Aurora IL 60504 USA, **declare under our sole responsibility that the below named**

Product: FieldScout TDR Soil Moisture Meter
Model Name (Product Number): TDR-150 (6445), TDR-250 (6250), and TDR-350 (6435)

Object of the Declaration:
FieldScout TDR Soil Moisture Meter providing a means for determining the volumetric water content (VWC) of a growing medium.
Specifications:

- Battery powered device (4 x AA batteries)
- 6.9cm (2.7") Backlit LCD Display
- Durable powder coated aluminum frame (TDR-250 and TDR-350)
- Hand-held Display UI and tethered sensor (TDR-150)
- Removable / Interchangeable sensing rods required for proper operation

to which this declaration relates, conform with the relevant requirements of the Harmonized Legislations mentioned below. Specifically, but not limited, to the following harmonized standards and/or normative documents:

Harmonization Legislation:
2016 No. 1091 The Electromagnetic Compatibility Regulations 2016
2012 No. 3052 The Restriction of the Use of Certain Hazardous Substances in Electrical and Electronic Equipment Regulations 2012

Safety of Information Technology Equipment
EN 60950-1:2006 + A1:2009 + A12:2011 + A2:2013 (as applied to internal Bluetooth module Silicon Labs BGM113A-V1 or BGM13P where used)
EN 60950-1:2006(second edition) + Am 1:2009 + Am 2:2013 (as applied to internal GNSS module Antenna Ltd. M20050-1 where used)

Electromagnetic Compatibility
BS EN 61000-6-1:2007 Immunity for residential, commercial, and light-industrial environments
BS EN 61000-6-3:2007 /A1:2011 Emission standard for residential, commercial, and light-industrial environments
BS EN 55032:2015 /A11:2020 Electromagnetic compatibility of multimedia equipment - Emission requirements
EN 301 489-1 V2.1.1 EMC standard for radio equipment and services; Part 1 (as applied to internal Bluetooth module Silicon Labs BGM113A-V1 or BGM13P and GNSS module Antenna Ltd. M20050-1 where used)
EN 301 489-1 V2.2.3; 2019-11 EMC standard for radio equipment and services; Part 1: Common technical requirements
EN 301 489-3 V2.1.1; 2019-03 EMC standard for radio equipment and services; Part 3: Specific conditions for Short-Range Devices
EN 301 489-17 v3.1.1 EMC standard for radio equipment and services; Part 17 (as applied to internal Bluetooth module Silicon Labs BGM113A-V1 or BGM13P where used)
EN 301 489-17 V3.2.4; 2020-09 EMC standard for radio equipment and services; Part 17: Specific conditions for Broadband Data Transmission Systems
EN 301 489-19 V2.1.1; 2019-04 EMC standard for radio equipment and services; Part 19: ... GNSS receivers operating in the RNSS band providing positioning, navigation, and timing data (as applied to internal GNSS module Antenna Ltd. M20050-1 where used)
EN 303 413 V1.1.1.1:2017 Global Navigation Satellite System (GNSS) receivers (as applied to internal GNSS module Antenna Ltd. M20050-1 where used)

Spectrum Efficiency
EN 300 328 V2.1.1 (as applied to internal Bluetooth module Silicon Labs BGM113A-V1 or BGM13P where used)
EN 300 440 V2.2.1: 2018-07 Short Range Devices 1-40 GHz; Emissions; EMC
EN 303 413 V1.1.1.1: 2017 Satellite Earth Stations and Systems; Global Navigation Satellite System (GNSS) receivers; (as applied to internal GNSS module Antenna Ltd. M20050-1 where used)

Article 3.3 Other Requirements
BS EN 63000:2018 Technical documentation for the assessment of electrical and electronic products with respect to the restriction of hazardous substances

Robert T Benesh
Robert T Benesh
Job Title: Electronics Engineer, TDR Product Manager
Email: rbenesh@specmeters.com



Declaration of Conformity
47 CFR § 2.1077 Compliance Information
Unique Identifier: FieldScout Soil Moisture Meter
6435 TDR-350, 6250 TDR-250, 6445 TDR-150

Responsible Party – U.S. Contact Information
Spectrum Technologies, Inc., 3600 Thayer Ct, Aurora IL 60504
Phone: (800) 248-8873 or (815) 436-4440 Fax: (815) 436-4460
E-Mail: info@specmeters.com Web: www.specmeters.com

Directive/Standard:
FCC Part 15: 2020: Emissions for Unintentional Radiators for USA (ANSI C63.4:2014)
ICES-003:2019: ITE Emissions for Canada (ANSI C63.4:2014)

FCC Compliance Statement
This device complies with part 15 of the FCC Rules. Operation is subject to the following two conditions: (1) This device may not cause harmful interference, and (2) this device must accept any interference received, including interference that may cause undesired operation.

Note: This equipment has been tested and found to comply with the limits for a Class B digital device, pursuant to Part 15 of the FCC Rules. These limits are designed to provide reasonable protection against harmful interference in a residential installation. This equipment generates, uses and can radiate radio frequency energy and, if not installed and used in accordance with the instructions, may cause harmful interference to radio communications. However, there is no guarantee that interference will not occur in a particular installation. If this equipment does cause harmful interference to radio or television reception, which can be determined by turning the equipment off and on, the user is encouraged to try to correct the interference by one or more of the following measures:
- Reorient or relocate the receiving antenna.
- Increase the separation between the equipment and receiver.
- Connect the equipment into an output on a circuit different from that to which the receiver is connected.
- Consult the dealer or an experienced RF technician for help.

This device contains licence-exempt transmitter(s)/receiver(s) that comply with Innovation, Science and Economic Development Canada's licence-exempt RSS(s). Operation is subject to the following two conditions:
(1) This device may not cause interference.
(2) This device must accept any interference, including interference that may cause undesired operation of the device.

This Class (B) digital apparatus complies with Canadian ICES-003.
Cet appareil numérique de la classe (B) est conforme à la norme NMB-003 du Canada.

 **Proper Disposal of Waste Electrical and Electronic Equipment**
This symbol when found on the product or packaging indicates that this product shall not be treated as common waste and that an effort to recycle materials should be made or may be required. Disposal of used and depleted electrical & electronic equipment may be subject to local laws and regulations for proper collection and recycling initiatives in the local area. This is applicable to areas within the European Union and other participating countries including the USA. The recycling of materials will help to conserve natural resources and prevent negative consequences of inappropriate waste handling at the end of a product's usable life. For more information about the recycling of waste electrical and electronic equipment, please contact your local civic office, waste disposal service, or the shop where the item was purchased.



www.specmeters.com

Spectrum Technologies, Inc.
"To Measure Is To Know"

3600 Thayer Court
Aurora, IL 60504
800.248.8873
www.specmeters.com

Spectrum and FieldScout are registered trademarks of Spectrum Technologies, Inc.

Form 179 (24-101)
Rev. B 01/2024

15